

SUPPLEMENTARY DATA

Supplementary Figure S1. Construct for conditional deletion of *Rdh10* exon 2. After crossing with CMV-Cre mice, a truncated *Rdh10* is translated that expresses only exon 1 from residues 1 to 98: 1-MNIVVEFFVVKVLWAFVLAARWLVRPKEKSVAGQVCLITGAGSGLGRLFALEFARRRALLVLWDINTQSNEETAGMVRHIYRDLEAADAAALQDH-98.

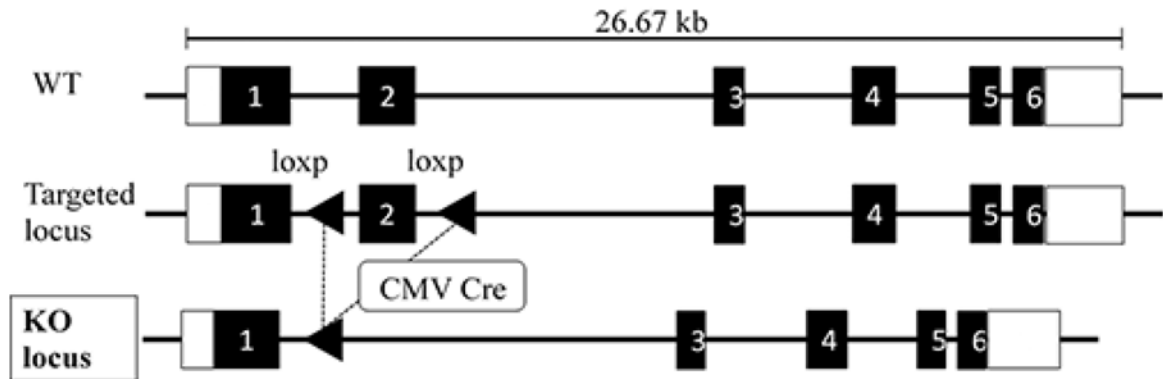

Supplementary Figure S2. Immortalized MEF induced to adipocyte differentiation imaged with oil red O on dd4. Control (WT) contained CRISPR, but had no mutations and had less than 10% differentiation. *Rdh10* knock-down (KO) clones 7, 13 and 27 had 80-90% differentiation. Clones WT6 and KO27 were used for detailed studies.

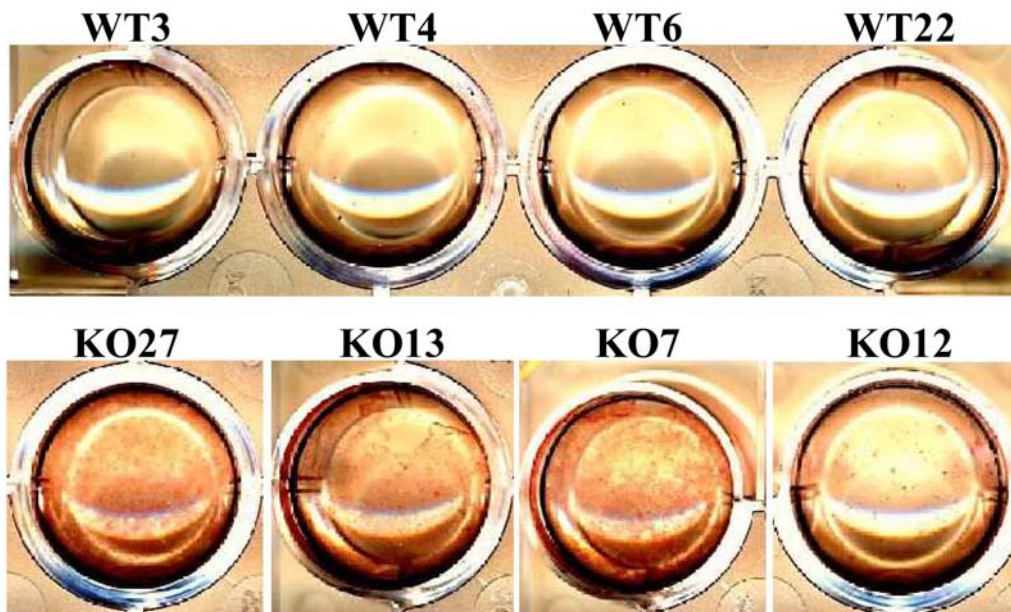

SUPPLEMENTARY DATA

Supplementary Figure S3. Retinoid metabolon gene compensation in HYPO MEF. Cells from 4 embryos/each genotype were assayed by qPCR: * $P < 0.03$.

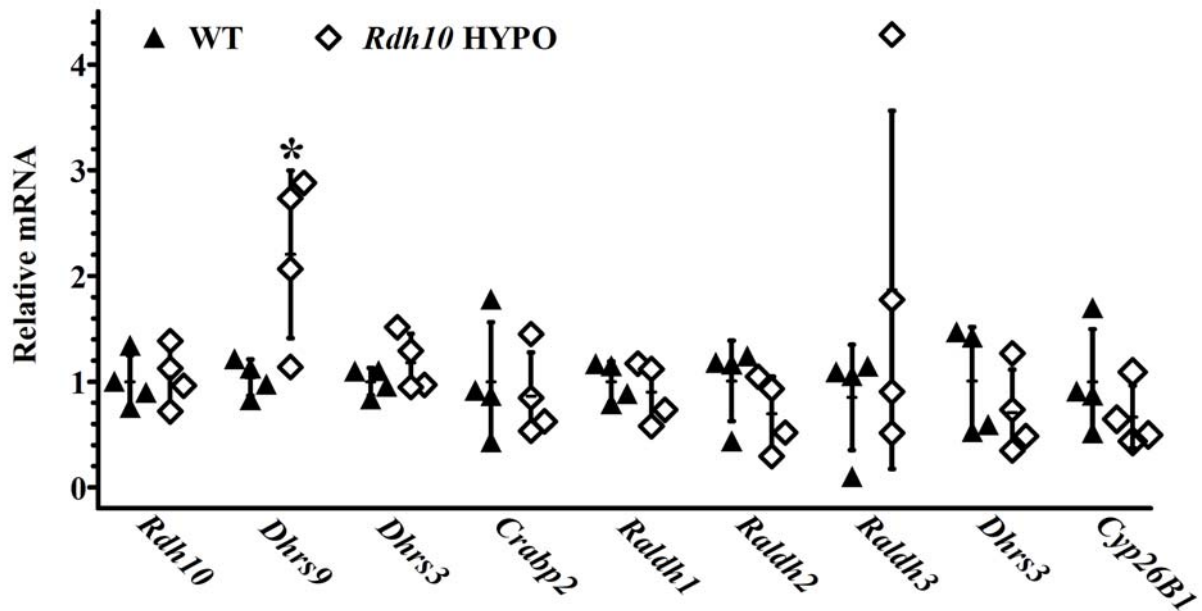

Supplementary Figure S4. Weight gain, fat body mass and GTT of mice fed a LFD. A. Body weights, WT males $n = 30$; $Rdh10^{+/-}$ males $n = 23$; WT females $n = 10$; $Rdh10^{+/-}$ females, $n = 9$. B. EchoMRI analysis of male body composition (WT $n = 13$, $Rdh10^{+/-}$ $n = 8$). C. GTT of 4-month-old males.

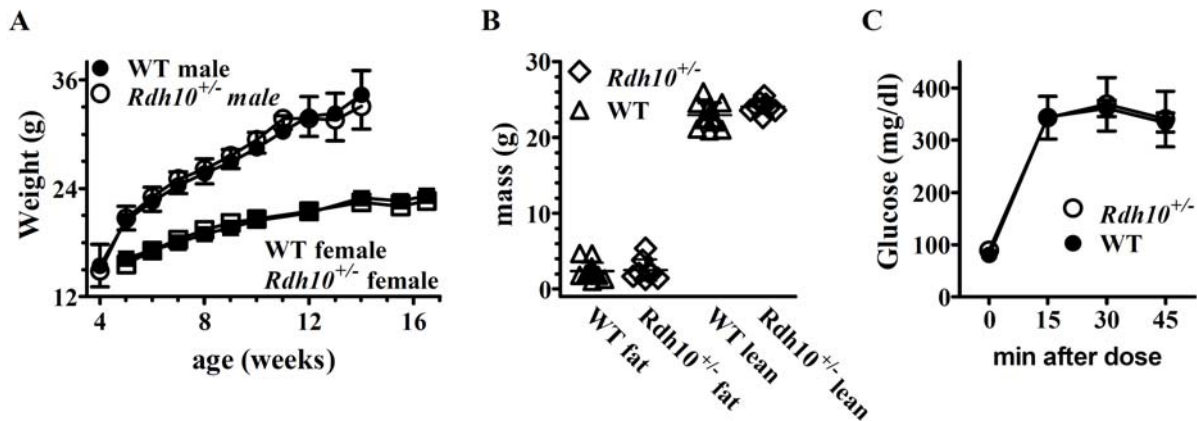

SUPPLEMENTARY DATA

Supplementary Figure S5. Food intake of mice fed a HFD. Mice were housed singly for 1 week. Food weights were taken at the beginning and end of the week. Data are from 6 WT and 10 *Rdh10*^{+/-}. This experiment was repeated with four different groups of mice.

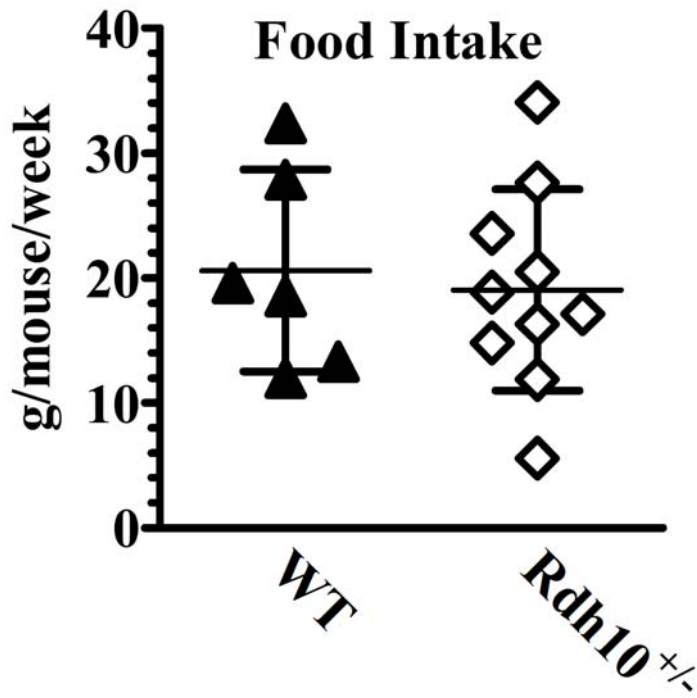

SUPPLEMENTARY DATA

Supplementary Figure S6. Energy expenditure and activity. A Columbus Instruments Comprehensive Lab Animal Monitoring System (CLAMS) was used to measure O₂ consumption, CO₂ production and physical activities of individual mice. Mice were acclimatized to the chamber cages for 24 hr before values were recorded. CLAMS was housed in a 12-hr light/dark cycle room. Fifteen recordings were taken from 7 AM to 7 PM (light cycle). Twelve recordings were taken from 7 PM to 7 AM (dark cycle). Mice had access to food and water at all times. No significant differences occurred between WT and *Rdh10*^{+/-}. VO₂ and VCO₂ were normalized to lean body mass

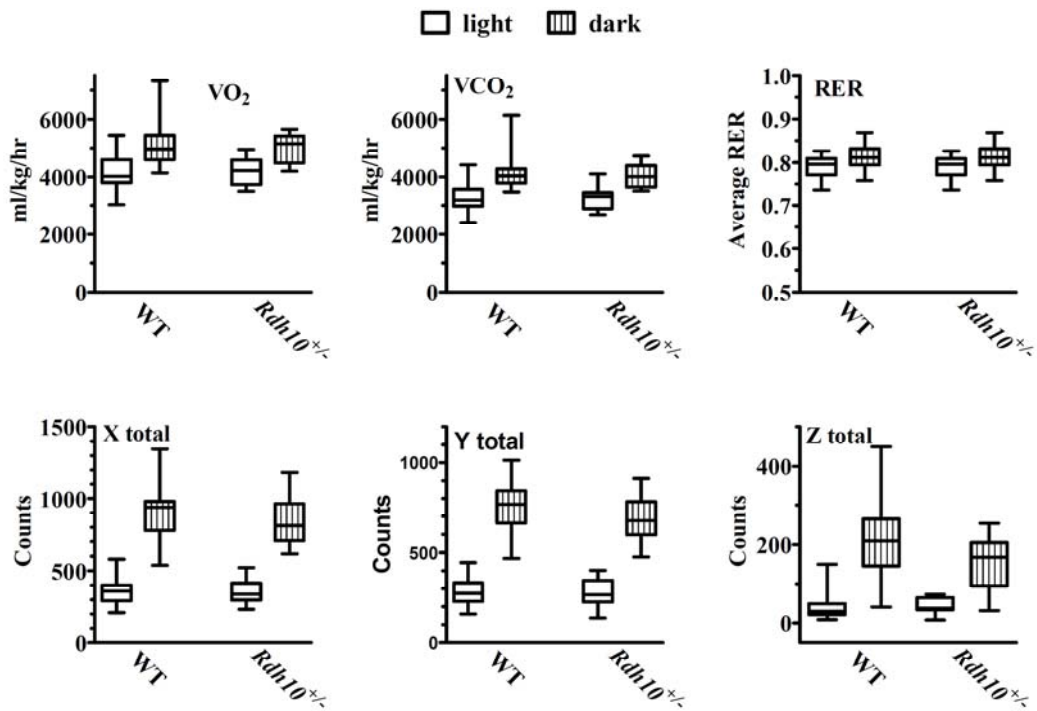

SUPPLEMENTARY DATA

Supplementary Figure S7. Variation of protein and adipose mass between WT and *Rdh10*^{+/-} mice.

The data illustrate changes in tissue mass and protein for male iWAT and eWAT and their impact on calculating changes in atRA between WT and *Rdh10*^{+/-} mice. In both WAT depots, mass and total protein increased in *Rdh10*^{+/-} mice vs. WT. In iWAT the protein concentration stayed the same as WT, but in eWAT the protein concentration decreased. Normalizing to protein indicated no change in atRA in eWAT, but a decrease in iWAT. Normalizing to tissue indicated a decrease in the atRA concentration in both fat pads. The latter is consistent with the decrease in atRA concentration in HYPO MEF treated with retinol (Fig. 1C), the function of pharmacological atRA in alleviating adiposity, and the rescue of the *Rdh10*^{+/-} phenotype by atRA (Fig. 7). atRA likely reflects increases in both total protein and mass and an uneven distribution among SVF cells, adipose and lipid droplets.

eWAT	WT	<i>Rdh10</i> ^{+/-}	<i>p</i>	% change
total weight (g)	1.5 ± 0.14 (9)	2.16 ± 0.27 (7)	< 0.04	44 ↑
protein (mg/g tissue)	10.3 ± 0.7 (9)	7.85 ± 0.46 (7)	< 0.02	24 ↓
total protein (mg)	15.5	17		10 ↑
atRA total (pmol)	6	6.9		15 ↑
atRA (pmol/mg protein)	0.39	0.41		~
atRA (pmol/g tissue)	4 ± 0.2 (7)	3.2 ± 0.08 (11)	< 0.002	20 ↓

iWAT	WT	<i>Rdh10</i> ^{+/-}	<i>p</i>	% change
total weight (g)	1.6 ± 0.16 (9)	2.5 ± 0.3 (7)	< 0.02	67 ↑
protein (mg/g tissue)	10 ± 1.1 (9)	11.4 ± 1.5 (8)	0.44	~
total protein (mg)	16	28.5		78 ↑
atRA total (pmol)	4.27	5.68		33 ↑
atRA (pmol/mg protein)	0.27	0.2		16 ↓
atRA (pmol/g tissue)	2.67 ± 0.16 (8)	2.27 ± 0.09 (11)	< 0.04	15 ↓

SUPPLEMENTARY DATA

Supplementary Figure S8. Serum β -hydroxybutyrate in fasted mice. Serum was prepared from 4-month-old mice fasted 16 hr. Data are from 7 WT males, 14 $Rdh10^{+/-}$ males, 3 WT females and 4 $Rdh10^{+/-}$ female mice.

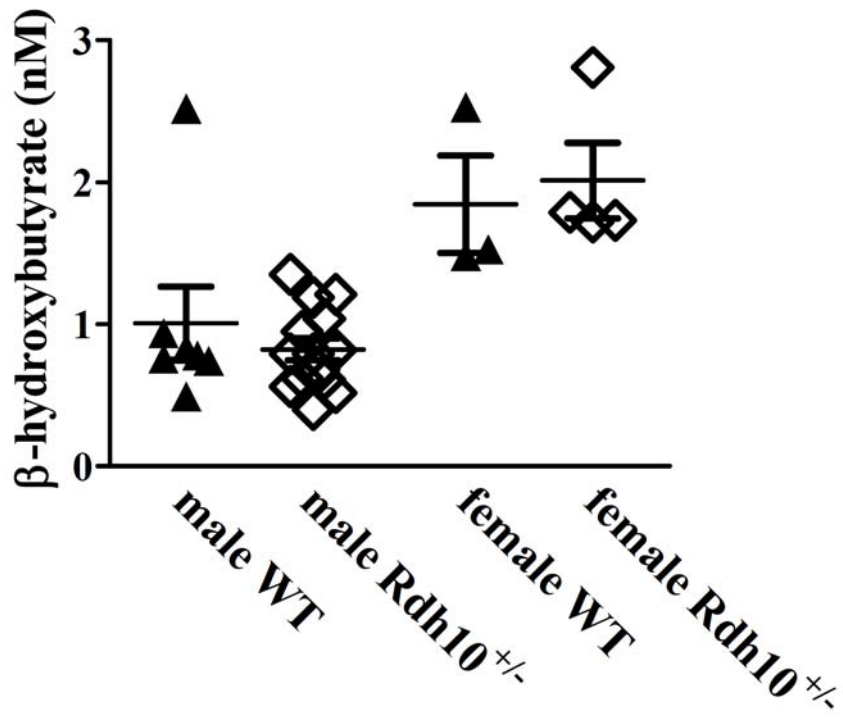

SUPPLEMENTARY DATA

Supplementary Figure S9. Serum adiponectin in fasted mice. Serum was prepared from 4-month-old mice fasted 16 hr. Data are from 7 WT males, 14 *Rdh10*^{+/-} males, 3 WT females and 4 *Rdh10*^{+/-} female mice.

qPCR. RNA from cells was extracted with TRI Reagent (Sigma T9424). Liver and adipose RNA were extracted with RNeasy Fibrous Tissue Mini Kit (#74704, Qiagen). Marrow RNA was extracted using a Zymo Research Direct-zolTM RNA MiniPrep kit. One μ g RNA was used for reverse transcription (iscript 170-8891 BioRad). RT-qPCR was performed with a Bio-RAD CFX Connect Real-Time Detection System.

aPCR primers. qPCR Primers were purchased from Life Technologies. *Acadm* (Mm01323360_g1), *Aldh1a1* (Mm00657317_m1), *Aldh1a2* (Mm00501306_m1), *Aldh1a3* (Mm00474049_m1), *Cpt1b* (Mm00487191_g1), *Cyp26A1* (Mm00514486_m1), *Cyp26B1* (Mm00558507_m1), *Dhrs3* (Mm00488080_m1), *Dhrs9* (Mm00615706_m1), *Fabp4* (Mm00445878_m1), *Fabp5* (Mm00783731_s1), *Gusb* (Mm01197698_m1), *Hif1a* (Mm01198376_m1), *Hmgcs2* (Mm00550050_m1), *Hnf4a* (Mm00433959_m1), *Ppara* (Mm00440939_m1), *Pparg* (Mm00440940_m1), *Pppar α 2* (Mm.PT.58.12797903), *Rarb* (Mm01319677_m1), *RdhE2* (Mm00725380_m1), *Rdh1* (Mm00650636_m1), *Rdh10* (Mm00467150_m1), *Saa1* (Mm00656927_g1), *Tbp* (Mm01277042_m1), *Saa3* (Mm00441203_m1), *Tnfa* (Mm00443258_m1), *Zfp423* (Mm00677660_m1).

